

BATTENED SEAT URB:SAT B220

URBAN EDGE
RANGE



INSTALLATION OPTIONS AND DIMENSIONS

Above ground epoxy-fix	1250mm L × 590mm W × 820mm H
Above ground bolt-fix	1250mm L × 590mm W × 820mm H
Below ground bolt-fix	1250mm L × 590mm W × 970mm H

FRAME MATERIALS

Clear anodised aluminium with cast aluminium corners.
Stainless steel fasteners.

BATTEN MATERIAL OPTIONS



HARDWOOD
Finished with 3 coats of water-based Intergrain Naturalstain, colour 'Cedar'.

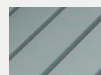

ALUMINIUM
Clear-anodised aluminium RHS with cast aluminium end-caps.



RECYCLED PLASTIC
ULTI-Plas™ UV stabilised extrusion, standard colour 'Charcoal'

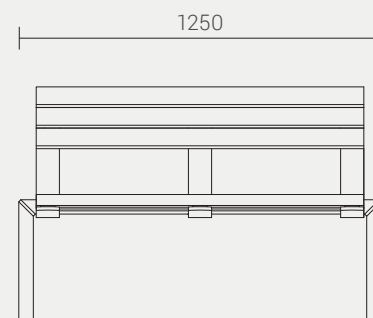
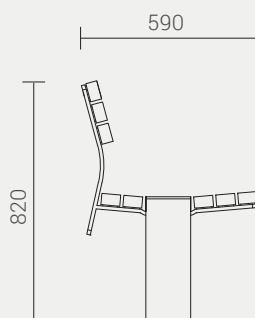

Designed by Cox Urban Furniture

E: info@coxurbanfurniture.com.au
WEB: coxurbanfurniture.com.au

Copyright © 2020 Cox Urban Furniture.

COX
URBAN FURNITURE

Distributed by Burdens Australia

HEAD OFFICE - WA

Burdens Australia
P: (08) 9302 4077
E: sales@burdens.net.au

11 Profit Pass
Wangara WA 6065

QUEENSLAND

Burdens Australia
P: (07) 3287 5166
E: qldsales@burdens.net.au

VICTORIA

Burdens Australia
P: (03) 9330 2752
E: vic-sales@burdens.net.au

INTERNATIONAL

Environmental Street Furniture
P: 0011 44 845 606 6095
E: sales@worldofesf.com

ESF Global Sales Office
67 Church Road
Newtownabbey, Belfast BT36 7LS
Northern Ireland