

MODULAR SEAT URB:SAT M110

URBAN EDGE
RANGE



INSTALLATION OPTIONS AND DIMENSIONS

Above ground epoxy-fix	650mm L × 545mm W × 900mm H
Above ground bolt-fix	650mm L × 545mm W × 900mm H
Below ground bolt-fix	650mm L × 545mm W × 1050mm H

FRAME MATERIALS

Clear anodised aluminium with cast aluminium corners.

Stainless steel fasteners.

SEAT MATERIAL OPTIONS



HARDWOOD

Finished with 3 coats of water-based Intergrain Naturalstain, colour 'Cedar'.

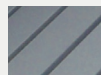

RECYCLED PLASTIC

Furnitureform™ HDPE, standard colour 'Charcoal'.

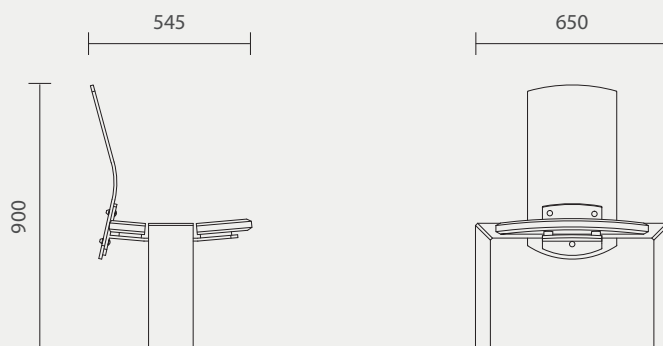

Designed by
Cox Urban Furniture
info@coxurbanfurniture.com.au
coxurbanfurniture.com.au

Distributed by Altiform,
National Sales Hotline
T. 1800 2584 3676
sales@altiform.com.au

Copyright © 2018 Cox Urban Furniture.

Not to be reproduced in any form
without prior written consent.