

MODULAR SEAT
URB:SAT M110

URBAN EDGE
RANGE



INSTALLATION OPTIONS AND DIMENSIONS

Above ground epoxy-fix	650mm L × 545mm W × 900mm H
Above ground bolt-fix	650mm L × 545mm W × 900mm H
Below ground bolt-fix	650mm L × 545mm W × 1050mm H

FRAME MATERIALS

Clear anodised aluminium with cast aluminium corners.
Stainless steel fasteners.

SEAT MATERIAL OPTIONS



HARDWOOD
Finished with 3 coats of water-based Intergrain Naturalstain, colour 'Cedar'.

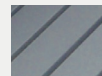

RECYCLED PLASTIC
ULTI-Plas™ UV stabilised extrusion, standard colour 'Charcoal'

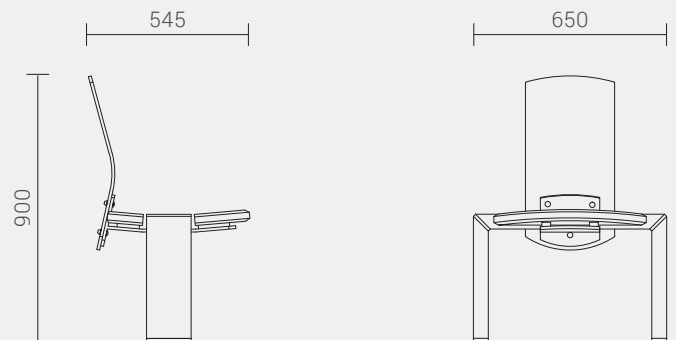

Designed by Cox Urban Furniture
E: info@coxurbanfurniture.com.au
WEB: coxurbanfurniture.com.au
Copyright © 2020 Cox Urban Furniture.



Distributed by Burdens Australia

HEAD OFFICE - WA
Burdens Australia
P: (08) 9302 4077
E: sales@burdens.net.au

11 Profit Pass
Wangara WA 6065

QUEENSLAND
Burdens Australia
P: (07) 3287 5166
E: qldsales@burdens.net.au

VICTORIA
Burdens Australia
P: (03) 9330 2752
E: vic-sales@burdens.net.au

INTERNATIONAL
Environmental Street Furniture
P: 0011 44 845 606 6095
E: sales@worldofesf.com

ESF Global Sales Office
67 Church Road
Newtownabbey, Belfast BT36 7LS
Northern Ireland